

AH08PTG-5A

EN Instruction Sheet
TR Bilgi Dökümanı
TW 安裝說明
CN 安装说明



5014003002
2022-05-13



www.deltaww.com



- EN ✎ This is an OPEN TYPE module and therefore should be installed in an enclosure free of airborne dust, humidity, electric shock and vibration. The enclosure should prevent non-maintenance staff from operating the device (e.g. key or specific tools are required for operating the enclosure) in case danger and damage on the device may occur.
- FR ✎ Ceci est un module ouvert et il doit donc être installé dans un coffret à l'abri des poussières, des vibrations et ne pas être exposé aux chocs électriques. Le boîtier ou l'armoire doit éviter toute action d'un personnel autre que celui affecté à la maintenance de l'appareil (par exemple, clefs, outils spécifiques pour l'ouverture du coffret), ceci afin d'éviter tout accident corporel ou endommagement du produit).
- TR ✎ Bu ürün AÇIK TIP bir modül olup toz, rutubet, elektrik şoku ve titreşimden uzak kapalı yerlerde muhafaza edilmelidir. Yanlış kullanım sonucu ürünün zarar görmesini önlemek için yetkili olmayan kişiler tarafından ürüne müdahale edilmesini önleyecek koruyucu önlemler alınmalıdır. (Ürünün bulunduğu panoya kilit konulması gibi).
- TW ✎ 本機為開放型 (OPEN TYPE) 機種，因此使用者使用本機時，必須將之安裝於具防塵、防潮及免於電擊衝擊意外之外殼配線箱內。另必須具備保護措施 (如：特殊之工具或鑰匙才可打開) 防止非維護人員操作或意外衝擊本體，造成危險及損壞。
- CN ✎ 本機為開放型 (OPEN TYPE) 機種，因此使用者使用本機時，必須將其安裝於具防塵、防潮及免於電擊/沖擊意外的外殼配線箱內。另必須具備保護措施 (如：特殊的工具或鑰匙才可打開) 防止非維護人員操作或意外沖擊本體，造成危險及損壞。

EN Please refer to the AH500 Series Hardware and Operation Manual for more information

TR Daha fazla bilgi için lütfen AH500 Serisi Donanım ve Kullanım Klavuzuna bakınız.

TW 詳細資料請參考 AH500 系列硬體及操作手冊

CN 详细资料请参考 AH500 系列硬件及操作手册

EN Assembly

TR Montaj

TW 安裝

CN 组装

EN Insert the module projections into the holes on the backplane. Then, push the module in the direction indicated by the arrow until it clicks. Finally, tighten the screws on the module.

TR Modül çıkıntısını alt panel üzerindeki deliklere yerleştiriniz. Daha sonra ok işareti ile gösterilen yönde tıklayıcıya kadar modülü itiniz. Son olarak modül üzerindeki vidaları sıkınız.

TW 將模組下方的卡勾卡在背板的卡槽，對準背板的 IO 介面將此模組向前壓，安裝後將此模組上方的螺絲鎖緊。

CN 將模块下方的卡勾卡在背板的卡槽，对准背板的 IO 接口将此模块向前压，安装后将此模块上方的螺丝锁紧。

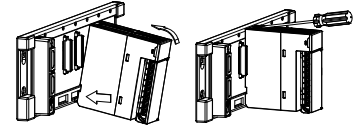

EN Input

TR Girişler

TW 輸入

CN 輸入

EN 8 input channels (2/3/4-wire RTD input); Sensor: PT100, PT1000, Ni100, Ni1000, or 0~300Ω; 20ms/4 channels, 200ms/8 channels

TR 8 giriş kanalı (2/3/4-kablolu RTD giriş); Sensör: PT100, PT1000, Ni100, Ni1000, or 0~300Ω; Çevrim zamanı: 20ms/4 kanal, 200ms/8 kanal

TW 8 通道輸入 (2/3/4 線 RTD 輸入) · 感測器形式：PT100、PT1000、Ni100、Ni1000 · 轉換時間：20ms/4 通道 · 200ms/8 通道。

CN 8 通道輸入 (2/3/4 线 RTD 輸入) · 传感器形式：PT100、PT1000、Ni100、Ni1000 · 转换时间：20ms/4 通道 · 200ms/8 通道。

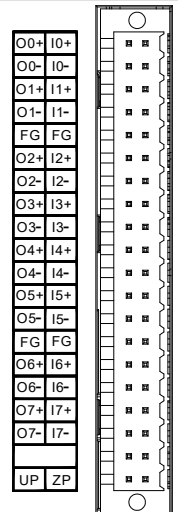

RTD 2/3/4WIRE

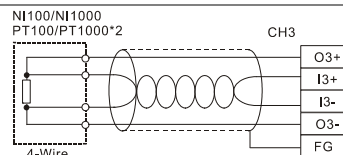
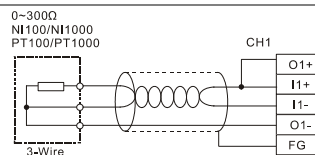
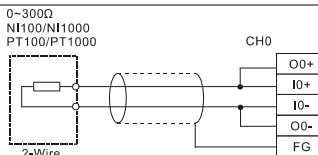

EN Dimensions(mm) & Product Profile

TR Ölçüler(mm) & Ürün Görünüşü

TW 尺寸(mm)及產品外觀

CN 尺寸(mm)及产品外观

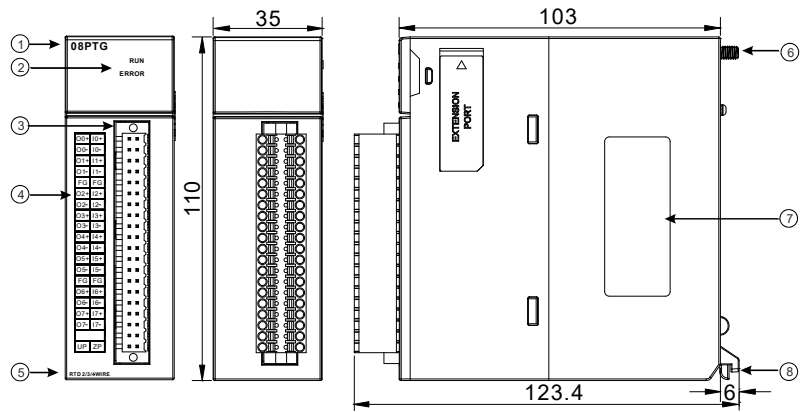

EN	TR	TW	CN
1 Model name	Model adı	機種名稱	机种名称
2 Run/Error indicator	Run/Error göstergesi	運行/錯誤指示燈	运行/错误指示灯
3 Removable terminal block	Sökülebilir terminal bloğu	脫落式端子	脱落式端子
4 I/O terminal configuration	I/O terminal yapılandırma	輸入輸出端子配置	输入输出端子配置
5 I/O description	I/O tanımı	輸入輸出說明	输入输出说明
6 Screw	Vida	固定螺絲	固定螺丝
7 Label	Etiket	標籤	标签
8 Module clip	Modül klipsi	模組固定卡口	模块固定卡口

EN Wiring TR Bağlantı TW 配線 CN 配线

EN The diameters of the cables are in the range of 30-24 AWG (0.3-0.6 mm). The lengths of the plastic jackets removed are in the range of 7-8 mm. The specifications for the terminals and the wiring are shown in the figure. The temperature of the copper conductor should be 60/75°C.

TR Kabloların çapı 30-24 AWG (0.3-0.6 mm) aralığında yer almaktadır. Plastik kılıf çıkarılma uzunluğu 7-8mm aralığında yer almalıdır. Terminal ve bağlantı özellikleri yandaki şekilde gösterildiği gibidir. Bakır iletkeni sıcaklığı 60/75°C olmalıdır.

TW 輸出 / 入配線端請使用 30-24AWG (0.3-0.6mm) 線材 · 線材撥線長度 7~8mm · 端子規格及配線示意圖如右所示 · 只能使用 60/75°C 的銅導線 ·

CN 輸出 / 入配線端請使用 30-24AWG (0.3-0.6mm) 線材 · 線材撥線長度 7~8mm · 端子規格及配線示意圖如右所示 · 只能使用 60/75°C 的銅導線 ·

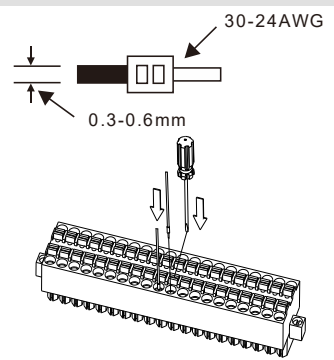

Part Name	Hazardous Substances						Industrial Automation Headquarters	
	Pb	Hg	Cd	Cr(VI)	PBB	PBDE	Delta Electronics, Inc.	Delta Greentech (China) Co., Ltd.
Metal Part	X	O	O	O	O	O	33068 桃園市桃園區興隆路 18 號	238 Min-Xia Road, Pudong District, Shanghai, P.R.C.
Plastic Part	O	O	O	O	O	O	886-3-3626301	86-21-5863-0003
Electronic	X	O	O	O	O	O	886-3-3716301	86-21-5863-0003
Contacts	O	O	X	O	O	O	中达电通股份有限公司	中达电通股份有限公司
Cable & Cabling accessories	X	O	O	O	O	O	地址: 上海市浦东新区区民路 238 号	地址: 上海市浦东新区区民路 238 号
Battery	O	O	O	O	O	O	邮编: 201209	邮编: 201209
<p>本表格依据 SJ/T 11364 的规定编制。 O: 表示该有害物质在该部件所有均质材料中的含量均在 GB/T 26572 规定的限量要求以下。 X: 表示该有害物质至少在该部件的某一均质材料中的含量超出 GB/T 26572 规定的限量要求。</p> <p>This table is made according to SJ/T 11364. O: Indicates that the concentration of hazardous substance in all of the homogeneous materials for this part is below the limit as stipulated in GB/T 26572. X: Indicates that concentration of hazardous substance in at least one of the homogeneous materials used for this part is above the limit as stipulated in GB/T 26572.</p>							<p>Industrial Automation Headquarters Delta Electronics, Inc. Taoyuan Technology Center No.18, Xinglong Rd., Taoyuan District, Taoyuan City, 33068, Taiwan TEL: 886-3-362-6301 / FAX: 886-3-371-6301</p> <p>Delta Greentech (China) Co., Ltd. 238 Min-Xia Road, Pudong District, Shanghai, P.R.C. 201209 TEL: 86-21-5863-5678 / FAX: 86-21-5863-0003</p>	
<p>Asia China: Delta Electronics (Shanghai) Co., Ltd. No.182 Minyu Rd., Pudong Shanghai, P.R.C. Post code: 201209 TEL: +86-21-6872-3988 / FAX: +86-21-6872-3996 Customer Service: 400-820-9595 Japan: Delta Electronics (Japan), Inc. Industrial Automation Sales Department 2-1-14 Shibadaimon, Minato-ku Tokyo, Japan 105-0012 TEL: +81-3-5733-1155 / FAX: +81-3-5733-1255 Korea: Delta Electronics (Korea), Inc. 1511, 219, Gasan Digital 1-Ro., Geumcheon-gu, Seoul, 08501 South Korea TEL: +82-2-515-5305 / FAX: +82-2-515-5302 Singapore: Delta Energy Systems (Singapore) Pte Ltd. 4 Kaki Bukit Avenue 1, #05-04, Singapore 417939 TEL: +65-6747-5155 / FAX: +65-6744-9228 India: Delta Electronics (India) Pvt. Ltd. Plot No.43, Sector 35, HSIDC Gurgaon, PIN 122001, Haryana, India TEL: +91-124-4874900 / FAX: +91-124-4874945</p>							<p>Thailand: Delta Electronics (Thailand) PCL. 909 Soi 9, Moo 4, Bangpoo Industrial Estate (E.P.Z), Pattana 1 Rd., T.Phraksa, A.Muang, Samutprakarn 10280, Thailand TEL: +66-2709-2800 / FAX: +66-2709-2827 Australia: Delta Electronics (Australia) Pty Ltd. Unit 20-21/45 Normanby Rd., Notting Hill Vic 3168, Australia TEL: +61-3-9543-3720 Americas USA: Delta Electronics (Americas) Ltd. 5101 Davis Drive, Research Triangle Park, NC 27709, U.S.A. TEL: +1-919-767-3813 / FAX: +1-919-767-3969 Brazil: Delta Electronics Brazil Ltd. Estrada Velha Rio-São Paulo, 5300 Eugênio de Melo - São José dos Campos CEP:12247-004-SP- Brazil TEL: +55-12-3932-2300 / FAX: +55-12-3932-237 Mexico: Delta Electronics International Mexico S.A. de C.V. Gustavo Baz No. 309 Edificio E PB 103 Colonia La Loma, CP 54060 Tlalneantla, Estado de México TEL: +52-55-3603-9200</p>	
<p>* 本手册内容若有变更，恕不另行通知。</p>							<p>* 本手册内容若有改动，恕不另行通知。</p>	
<p>EMEA EMEA Headquarters: Delta Electronics (Netherlands) B.V. Sales: Sales.IA.EMEA@deltaww.com Marketing: Marketing.IA.EMEA@deltaww.com Technical Support: iatechnicalsupport@deltaww.com Customer Support: Customer-Support@deltaww.com Service: Service.IA.emea@deltaww.com TEL: +31(0)40 800 3900 BENELUX: Delta Electronics (Netherlands) B.V. Automotive Campus 260, 5708 JZ Helmond, The Netherlands Mail: Sales.IA.Benelux@deltaww.com TEL: +31(0)40 800 3900 DACH: Delta Electronics (Netherlands) B.V. Coesterweg 45, D-59494 Soest, Germany Mail: Sales.IA.DACH@deltaww.com TEL: +49(0)2921 987 0 France: Delta Electronics (France) S.A. ZI du bois Challand 2, 15 rue des Pyrénées, Lisses, 91090 Evry Cedex, France Mail: Sales.IA.FR@deltaww.com TEL: +33(0)1 69 77 82 60 UK: Delta Electronics Europe Ltd. 1 Redwood Court, East Kilbride, Glasgow, G74 5PF, United Kingdom TEL: +44-1355-588-888</p>							<p>Iberia: Delta Electronics Solutions (Spain) S.L.U. Ctra. De Villaverde a Vallecas, 265 1º Dcha Ed. Hormigueras - P.I. de Vallecas 28031 Madrid TEL: +34(0)91 223 74 20 Carrer Llacuna 166, 08018 Barcelona, Spain Mail: Sales.IA.Iberia@deltaww.com Italy: Delta Electronics (Italy) S.r.l. Via Media 2-22060 Novedrate(CO) Piazzza Grazioli 18 00186 Roma Italy Mail: Sales.IA.Italy@deltaww.com TEL: +39 039 8900365 Russia: Delta Energy System LLC Vereyskaya Plaza II, office 112 Vereyskaya str. 17 121367 Moscow Russia Mail: Sales.IA.RU@deltaww.com TEL: +7 495 644 3240 Turkey: Delta Greentech Elektronik San. Ltd. Sti. (Turkey) Şenfall Mah. Hennem Cad. Kule Sok. No:16-A 34775 Ümraniye - İstanbul Mail: Sales.IA.Turkey@deltaww.com TEL: +90 216 499 9910 MEA: Eltek Dubai (Eltek MEA DMCC) OFFICE 2504, 25th Floor, Saba Tower 1, Jumeirah Lakes Towers, Dubai, UAE Mail: Sales.IA.MEA@deltaww.com TEL: +971(0)4 2690148</p>	

*We reserve the right to change the information in this instruction sheet without prior notice.